

TH 1117 / TL 1117
DECK MOUNTED BATH BRIDGE MIXER
INSTALLATION GUIDE

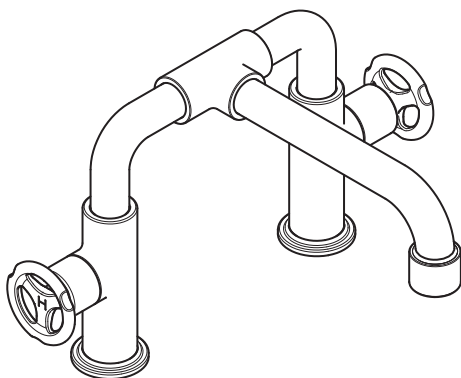

LEFROY BROOKS

DIMENSIONS

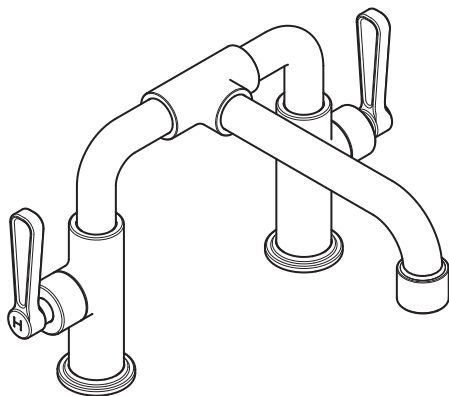
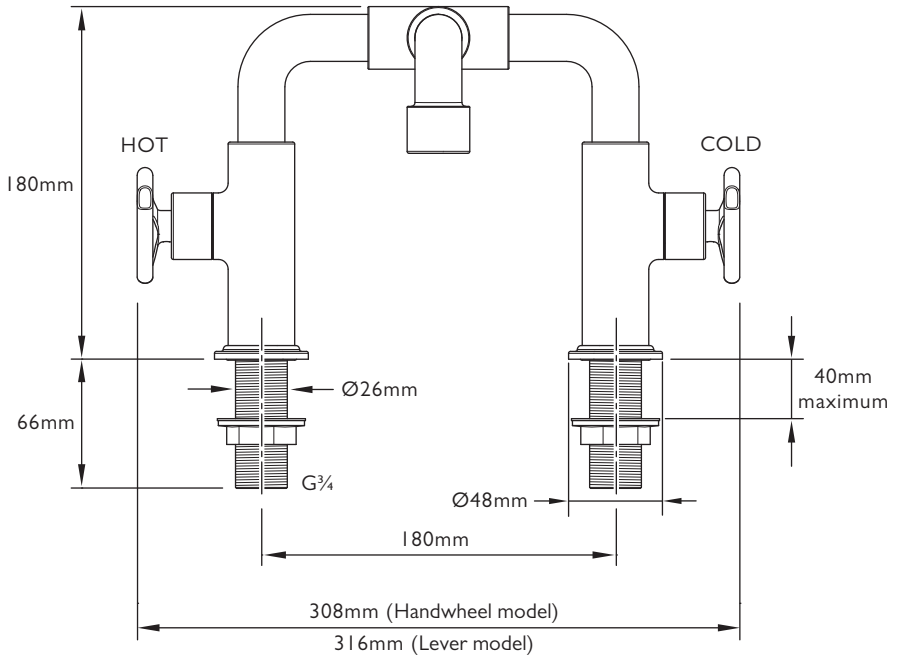

Not to scale

DIMENSIONS

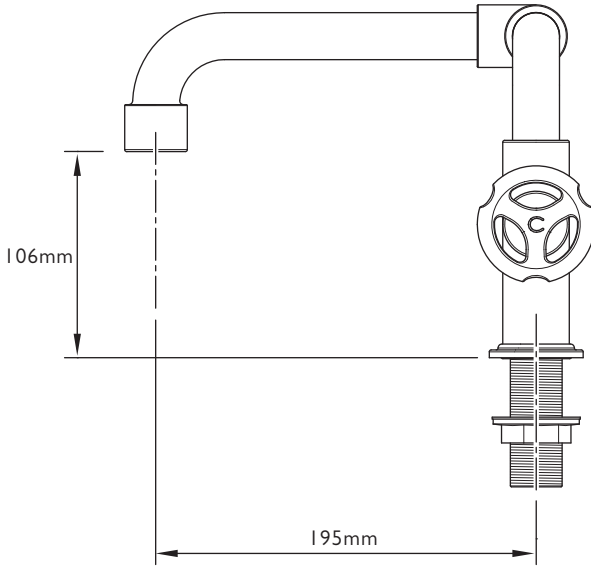

Not to scale

TYPICAL FLOW RATES

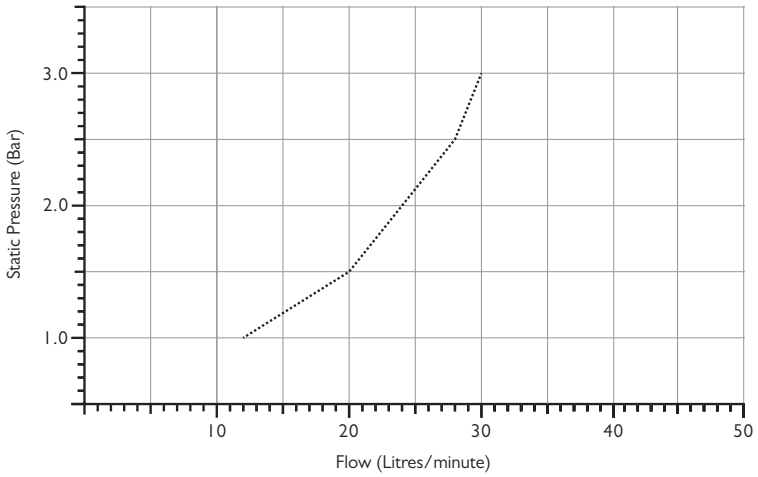

Note: Balanced pressures shown are applied directly to the hot and cold inlets; flow rates indicated are free flowing and may vary subject to restrictions created by installation, pipework, layout or application.

IMPORTANT INFORMATION

Professional installation

We recommend that our products are fitted by a fully qualified professional plumber. They should be installed correctly and in accordance with all local water regulations and the system protected by non-return valves (not supplied). All products should be accessible for routine servicing.

Suits all systems

This Lefroy Brooks product is potentially suitable for every possible application, type of boiler and water supply pressure. However, if your supply pressure is below 1 bar it is advisable to fit a water pump. For systems with combination boilers, it is not advisable to fit pumps (refer to boiler manufacturer).

Supply connections

The HOT water supply should be connected to the LEFT inlet and COLD to the RIGHT inlet as viewed from the front.

Supply temperature safety notice

To comply with local building regulations, current legislation, relevant standards and codes of practice a thermostatic mixing valve (TMV) should be fitted (not supplied) to the hot supply. This will restrict the temperature to a safe working maximum temperature. Maximum allowed temperatures vary subject to type of installation or specification of building.

Balancing flow

If there is a significant difference in water pressures between hot & cold supplies, we recommend an in-line flow suppressor/regulator (not supplied) be fitted. This should be fitted to whichever has the greater flow rate, in an accessible position close to the valve.

Water quality

In hard water areas, a suitable water treatment system should be provided to prevent limescale deposits (calcium deposits) which may effect the long term performance of the ceramic cartridges. Exterior surfaces should be gently wiped with a dry soft cloth after use to minimise water stains and limescale deposits.

Flushing system

It is most important to flush out all pipework thoroughly before connecting the product. Failure to do so is the single most common cause of ceramic cartridge failure.

Servicing

All serviceable parts are available to maintain your Lefroy Brooks product.

INSTALLATION

Shown with handwheels. The same procedure applies to lever models.

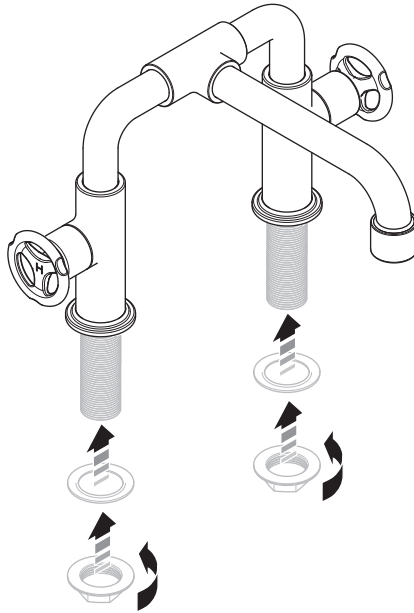

- 1 Where required, drill $\text{Ø}28\text{--}30\text{mm}$ holes in the mounting surface.
- 2 Place the threaded tails of the bridge mixer through the holes in the mounting surface.
- 3 Locate the washers onto the threaded tails.
- 4 Screw the backnuts onto the threaded tails and tighten to secure the bridge mixer.
- 5 After flushing the pipework connect the hot and cold water supplies.
- 6 Pressure test the installation to ensure that all joints are tight and do not leak, especially where pipework will be concealed.

SERVICING – CARTRIDGE REPLACEMENT

Shown with handwheels. The same procedure applies to lever models.

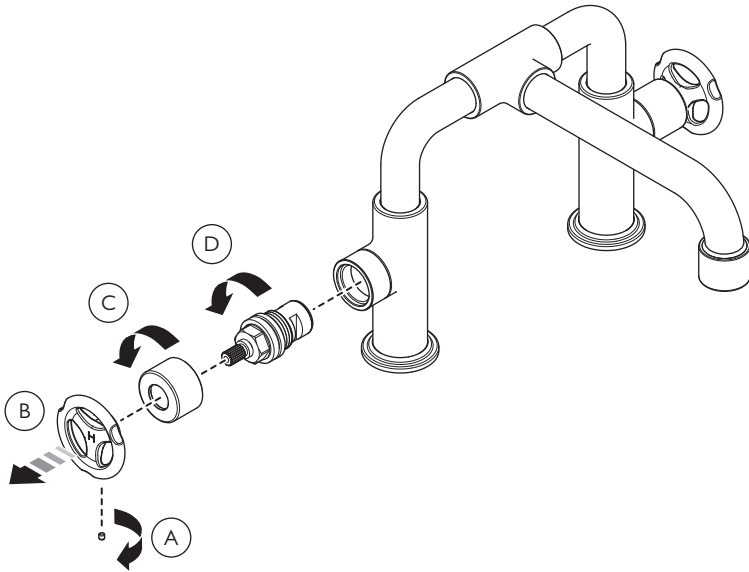

Before continuing please ensure that the water supplies have been isolated and drained where necessary.

- 1 To remove the ceramic cartridge(s), unscrew the set screw(s) in the underside of the handwheel(s)/lever(s) (A) using a 2mm hexagonal key.
- 2 Pull the handwheel(s)/lever(s) to remove (B).
- 3 Unscrew and remove the shroud(s) (C). We recommend this is done by hand as tools may damage the decorative surface. To aid grip we recommend wearing rubber gloves such as those used for washing up.
- 4 Unscrew and remove the ceramic cartridge(s) using a 17mm spanner (D).
- 5 Assemble in the reverse order.

SERVICING – CLEANING THE SPOUT AERATOR

Shown with handwheels. The same procedure applies to lever models.

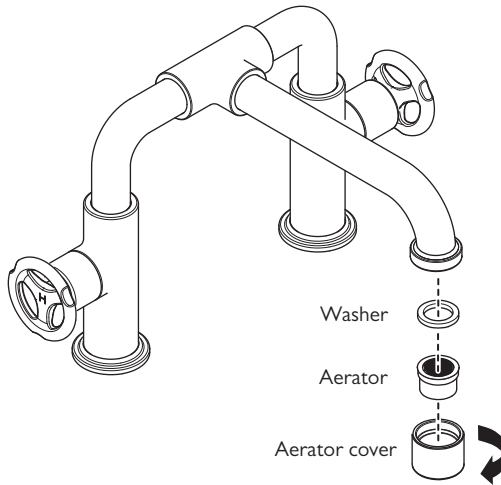

1 There is an aerator located in the end of the spout. To remove the aerator unscrew and remove the aerator cover.

2 The aerator can be cleaned in warm soapy water or replaced.

3 Assemble in the reverse order.

FAULT FINDING

The hot / cold valves are turned off but the spout drips continuously.

- Replace the ceramic cartridge(s). See below for spare part numbers.

Water flow from the spout is reduced.

- Debris from the water supply may be causing restriction at the aerator located in the end of the spout. The aerator can be removed for cleaning. See 'servicing – cleaning the spout aerator' section.

REPLACEMENT PARTS

Both handwheel and lever models use ¼ turn ceramic cartridges.

PHL036 – Pair of ¾" x ¼ turn ceramic cartridges (one counter clockwise closing (left side) and one clockwise closing (right side)).

PHL042 – Single ¾" x ¼ turn ceramic cartridge (clockwise closing – right side).

PHL043 – Single ¾" x ¼ turn ceramic cartridge (counter clockwise closing – left side).

PFR020 – Aerator and aerator washer.

PSH098 – Aerator sleeve.



CONTRACT ENQUIRIES

+44 (0)1992 708 316

info@lefroybrooks.co.uk

CUSTOMER SERVICE, SPARES & TECHNICAL ENQUIRIES

+44 (0)1902 390 894

technical@lefroybrooks.co.uk

LEFROYBROOKS.CO.UK

Whilst every effort is made to ensure the accuracy of these, they are subject to change without notice as part of the company's product development process. The use of trademarks, product design and artwork is subject to licence or agreement with LBIP Ltd. The design registrations, trademark registrations and copyrights are protected by law and the use or reproduction outside the terms of an agreement is prohibited. The right to modify designs and dimensions is reserved. LBIP Ltd is a member of ACID (Anti Copying in Design). E&OE